

Print 'n' Play Collection Of the 12 Matchstick Puzzles

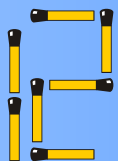

MA
TC
HES



Puzzles

Puzzles
COM

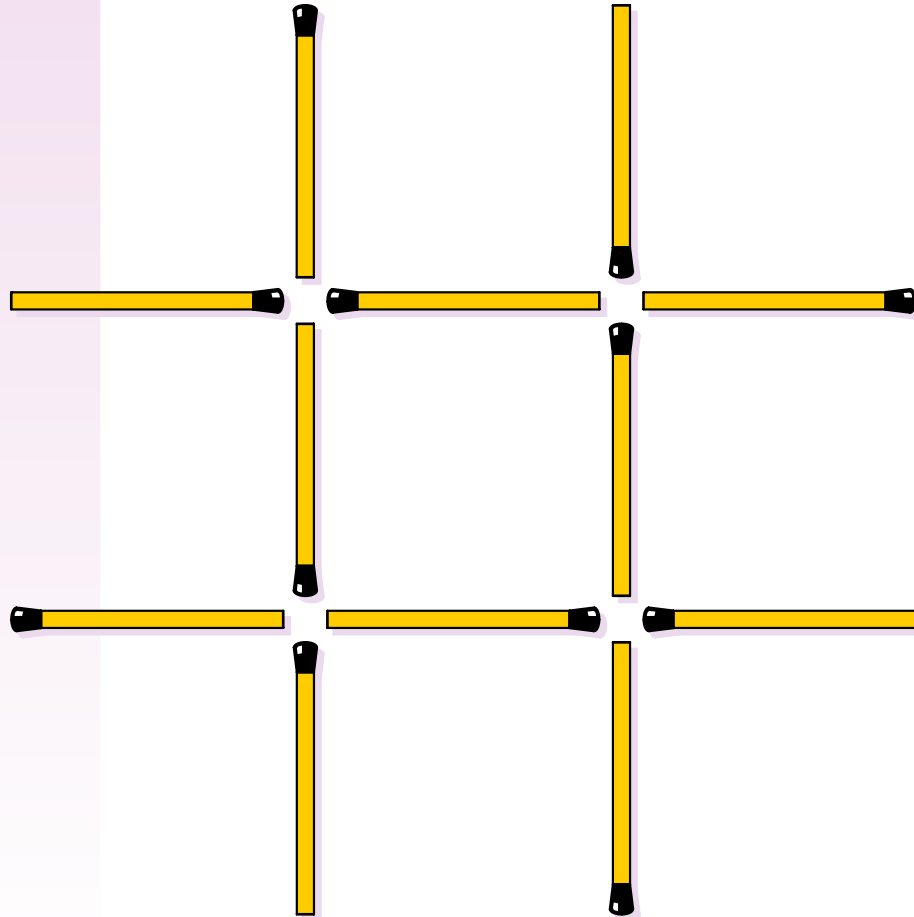

The Three Squares

Take twelve matches and arrange them into the grid shown in the illustration.

Now move only three matches so that to get exactly three perfect squares.

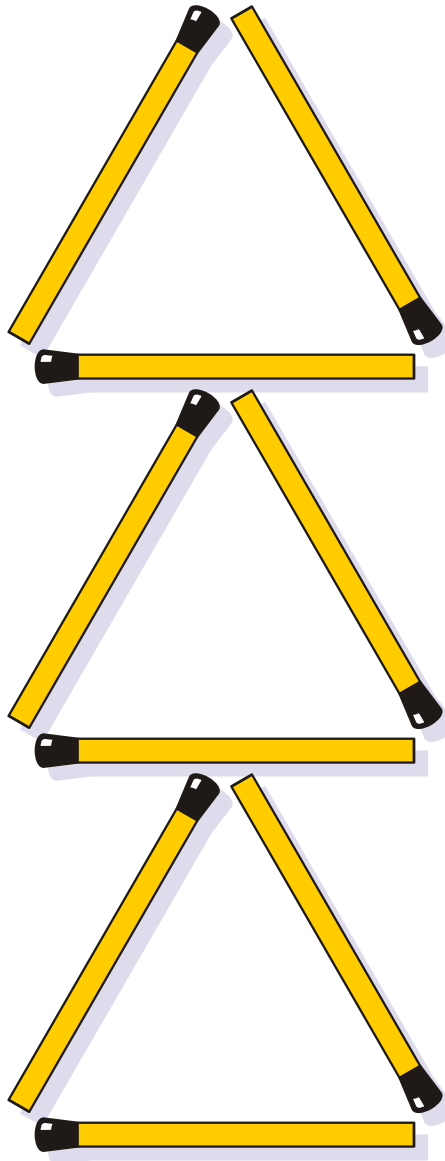

The Christmas Tree shown in the illustration contains exactly three equilateral triangles.

The object is to move three matches so that to get four equilateral triangles.

Overlapping of the matches is not allowed.

Last Updated: March 24, 2006

Page 3 of 27

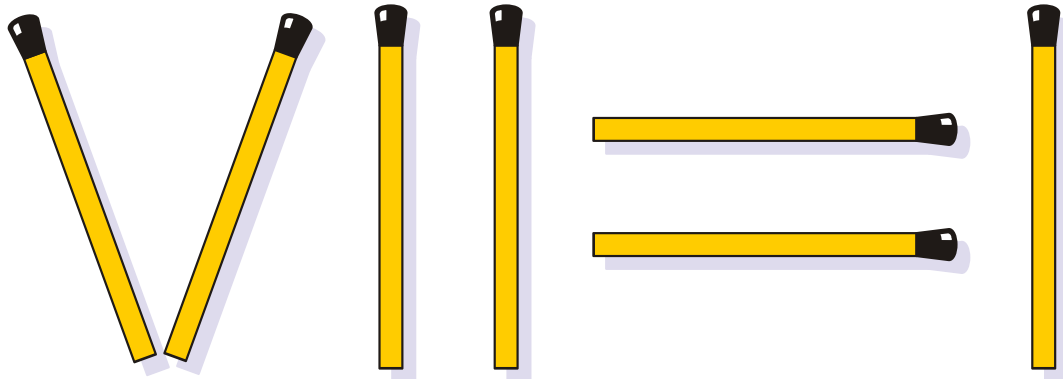

Arrange seven matches into the equation shown in the illustration. It can be seen the equation itself is not correct.

Puzzle 1. Move one match to a new position in order to make this equation correct.

Puzzle 2. Move three matches to new positions to get a correct equation. This puzzle can be solved in two different ways.

Puzzle 3*. Move two matches to new positions to get a correct equation.

In all three puzzles it is not allowed to break the matches and an equation sign has to remain in the final expression.

*The puzzle with a complete solution has been sent to us by Roger Kirkman. Many thanks!

Last Updated: March 24, 2006

Page 4 of 27

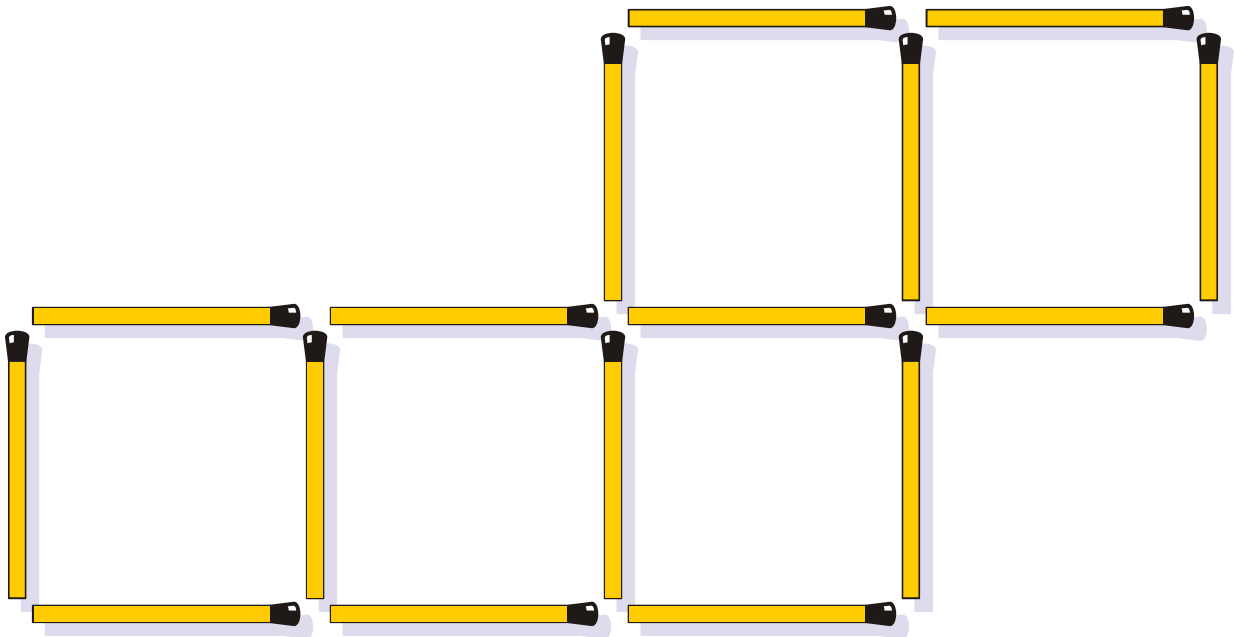

Take sixteen matches and arrange them into five squares as shown in the illustration.

The object is to move two matches to new positions to get exactly four identical squares instead of five.

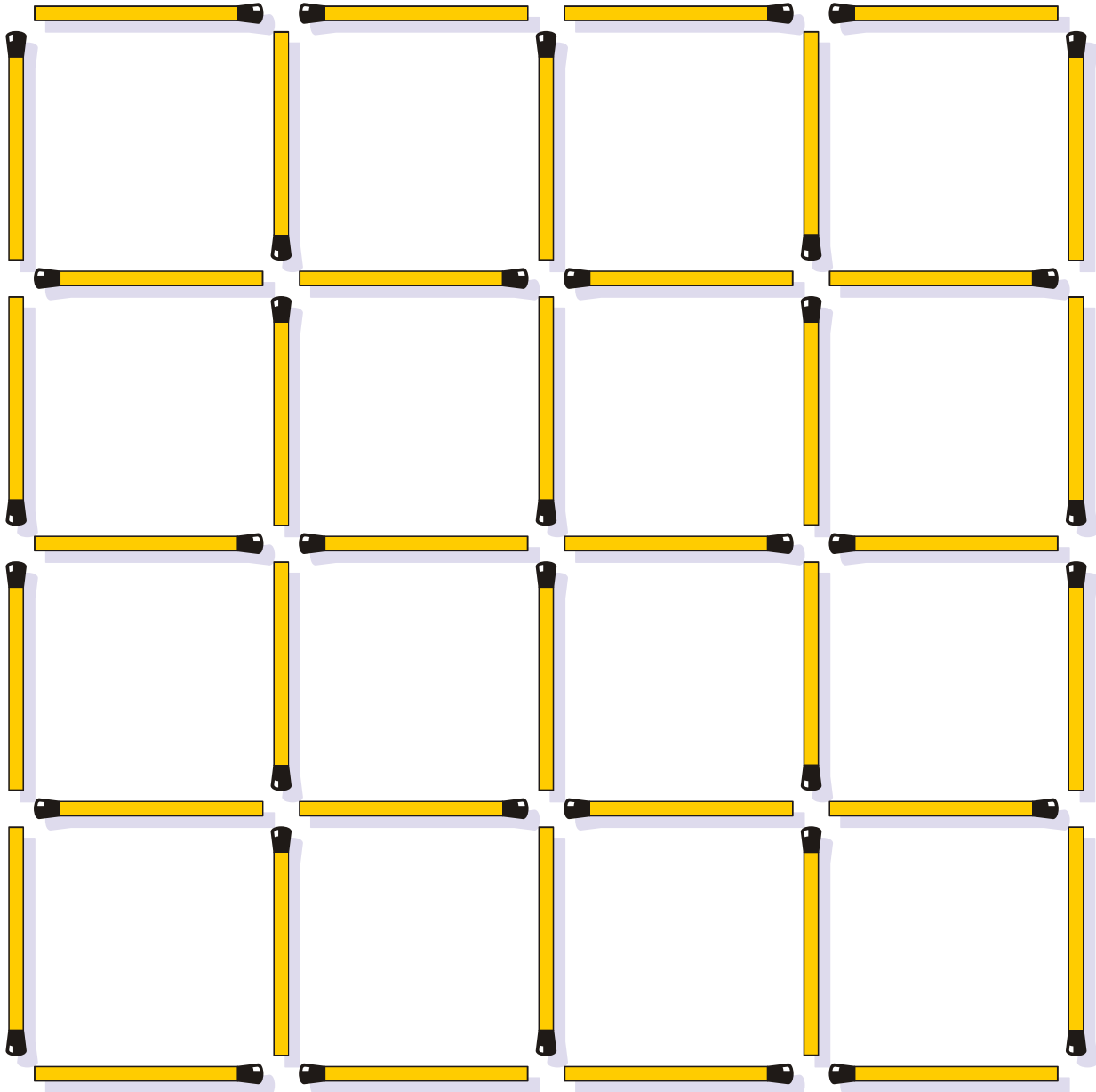

Arrange the 4x4 match square grid as shown in the illustration. The object of the puzzle is to remove nine matches so that no square (of any size) will remain.

Last Updated: March 24, 2006

Page 6 of 27

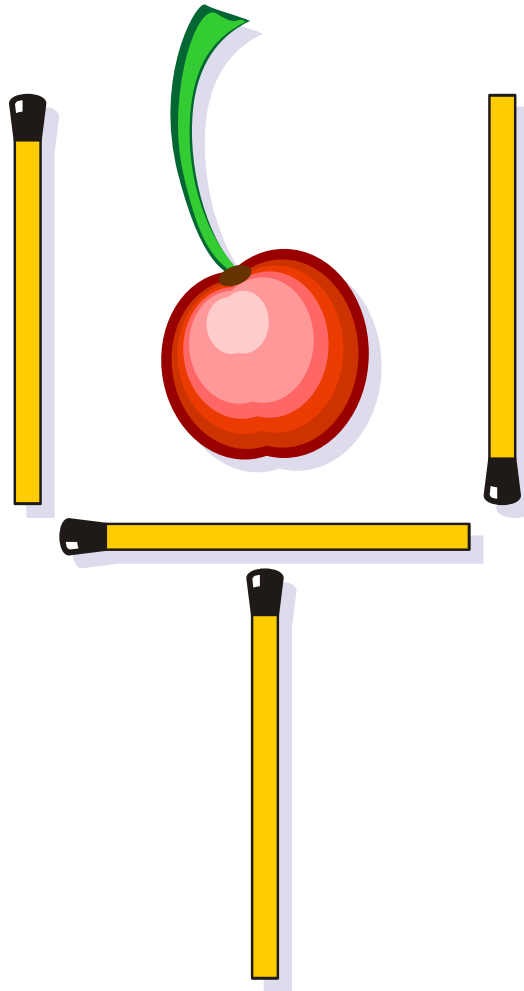

The object is to move 2 matches to get the cherry outside the glass. At the finish, the glass may be turned in any direction, but it must be exactly the same shape as before.

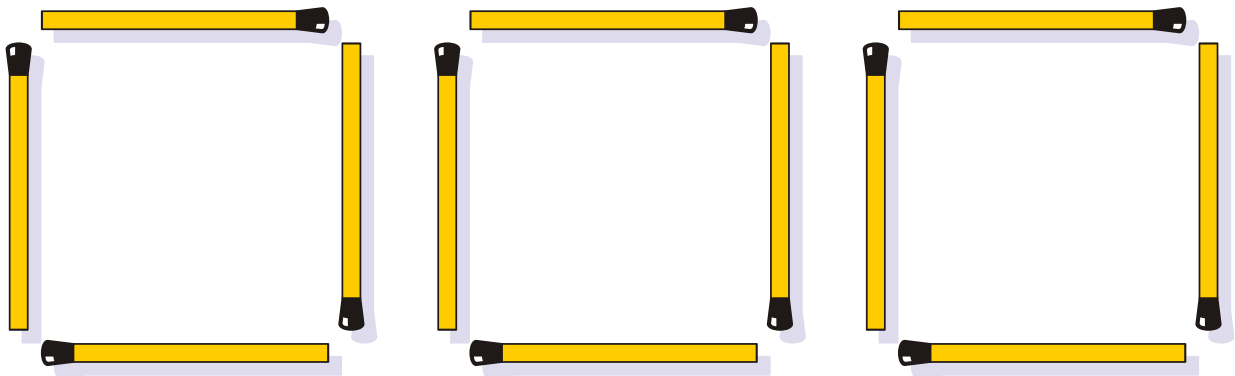

Move two matches to get the exact time half past four.

Overlapping of the matches is not allowed.

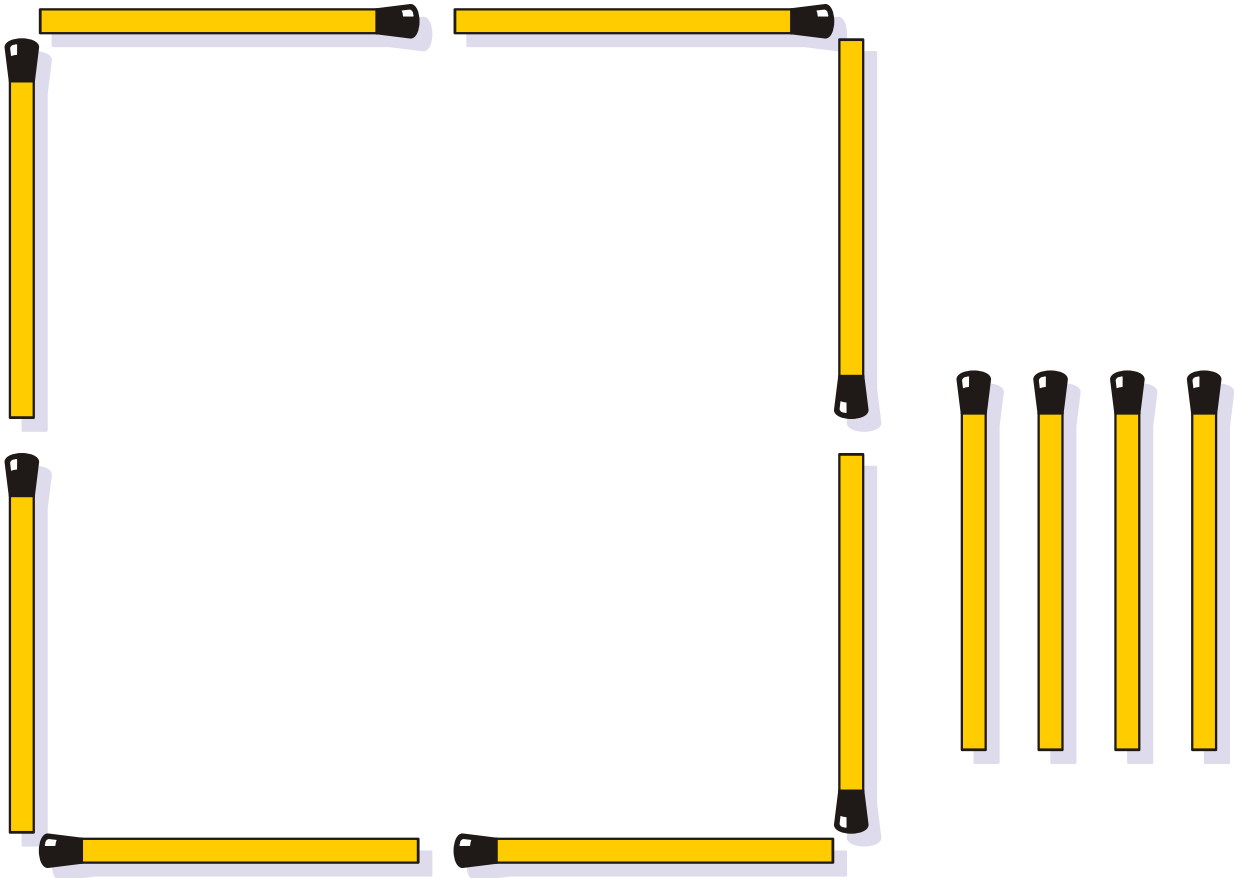

Take eight matches and form the 2x2 square shown in the illustration.

The object is to divide this square with the four additional matches into two parts of the same area and shape.

You have to use matches with their full lengths without cutting, breaking or overlapping them.

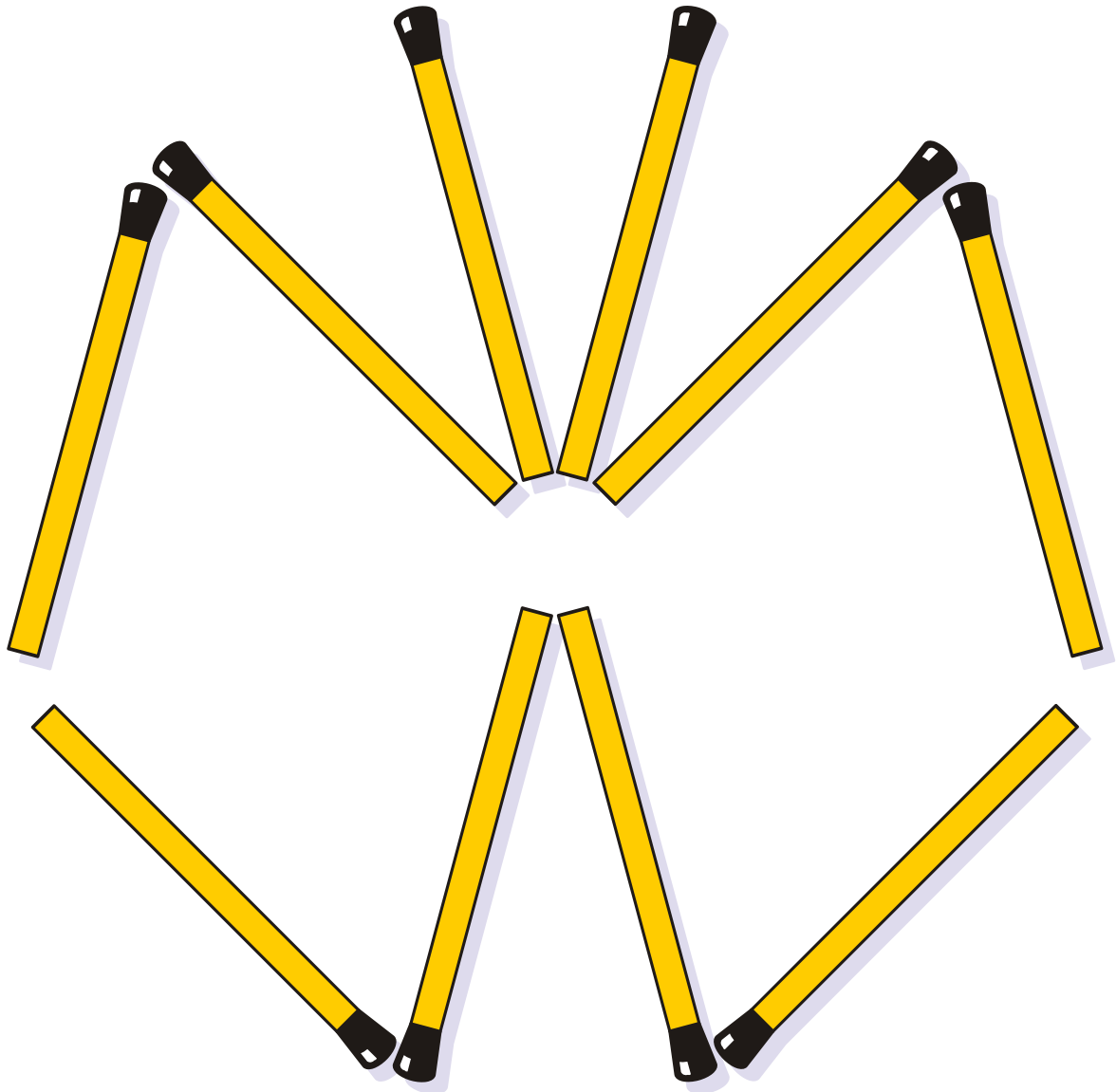

Move only three matches so that the bat will fly in another direction.

Last Updated: March 24, 2006

Page 10 of 27

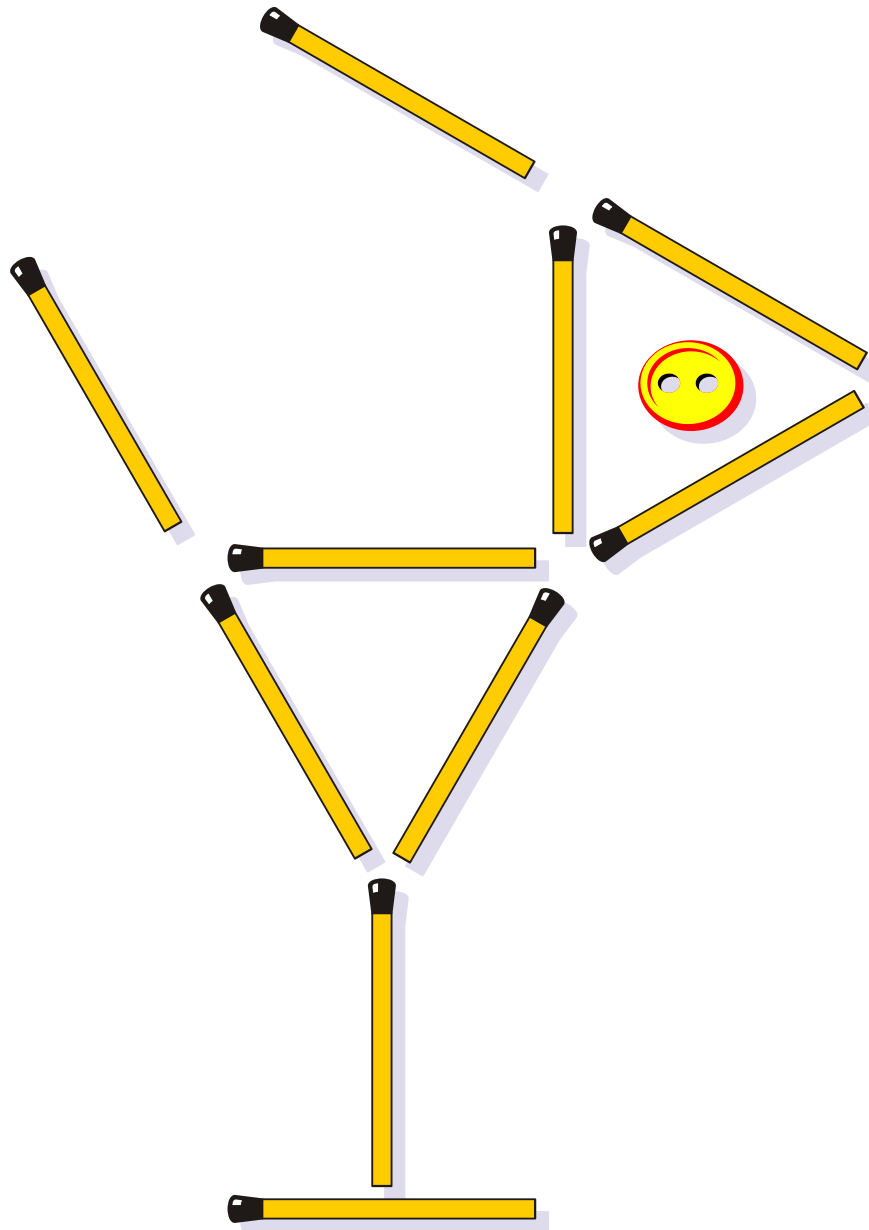

Form the depicted bird with ten matches and the button as shown. Move two matches and a button to make the bird looking in another direction.

Last Updated: March 24, 2006

Page 11 of 27

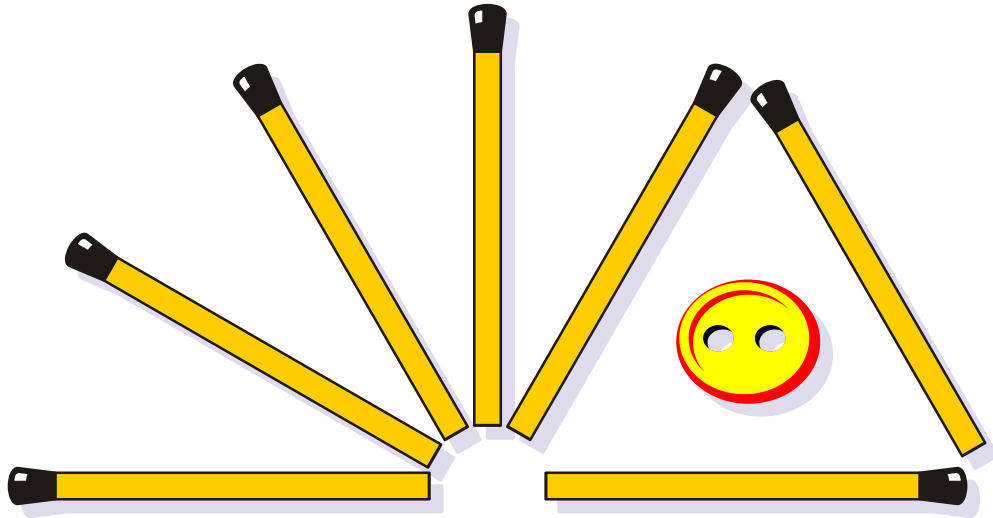

Arrange seven matches and a button to form the hedgehog shown in the illustration.

The object is to make the hedgehog running in another direction moving every time the button

and:

- a) two matches;
- b) three matches;
- c) five matches.

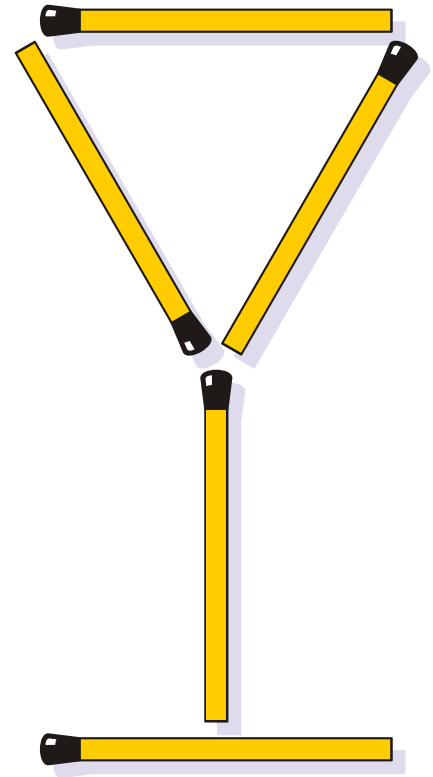
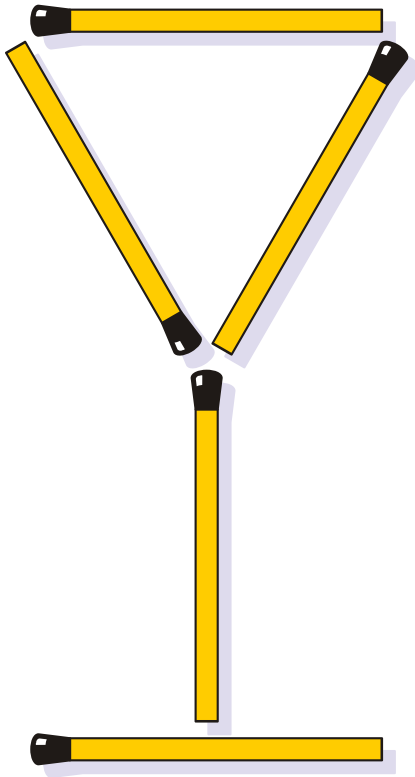

The idea of this puzzle appeared in Bryant & May's little book of matchstick puzzles at the beginning of the 20th century.

The illustration above shows two wine glasses arranged from ten matches.

The object is to move six of them in such a way that to get a house instead of these wine glasses.

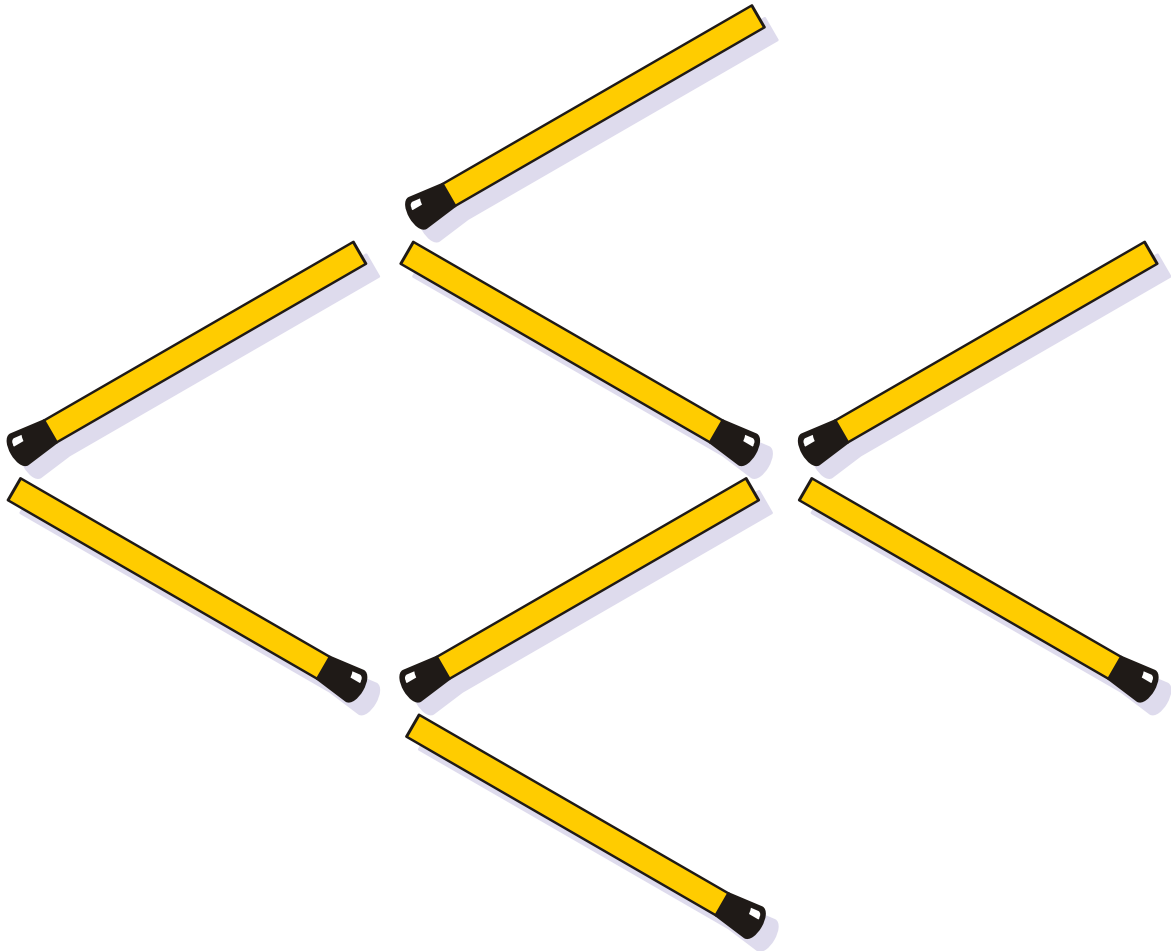

Arrange 8 matchsticks to form a fish swimming left as shown in the illustration.

Move 3 matchsticks to make the fish swimming right.

MA
TC
HES

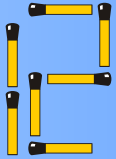

Solutions

Puzzles
COM

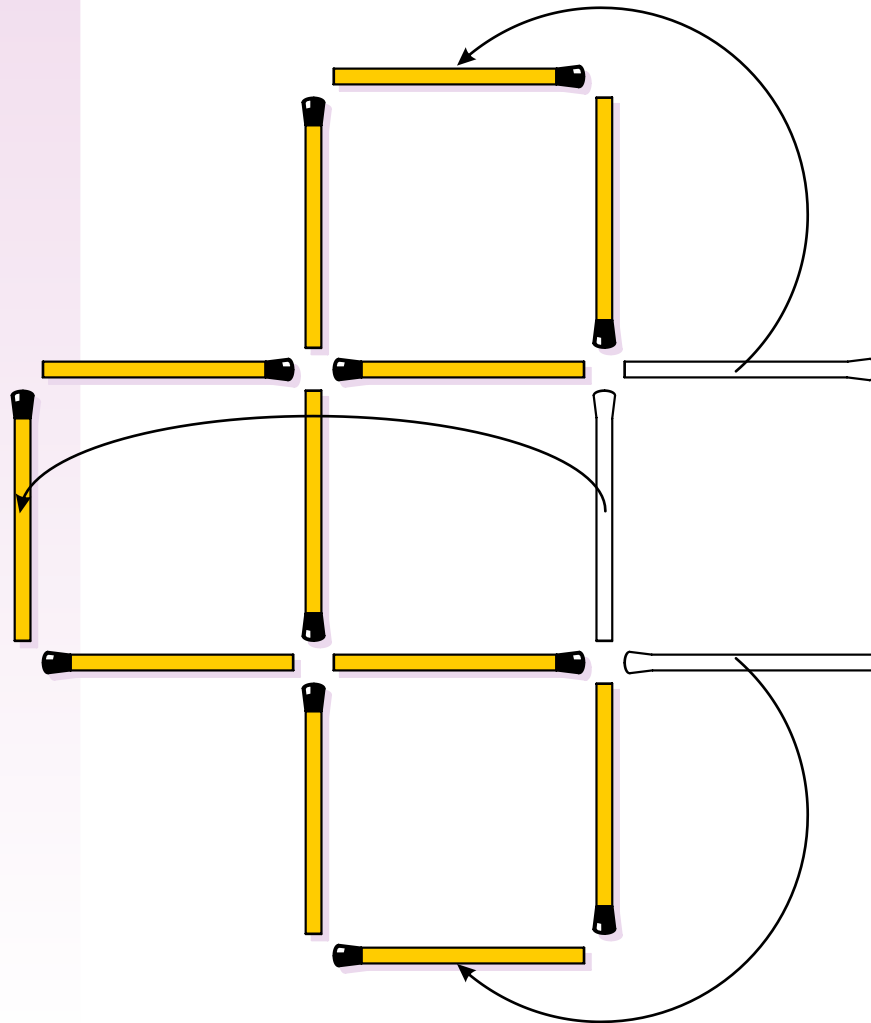

The Three Squares (solution)

The solution is shown in the illustration.

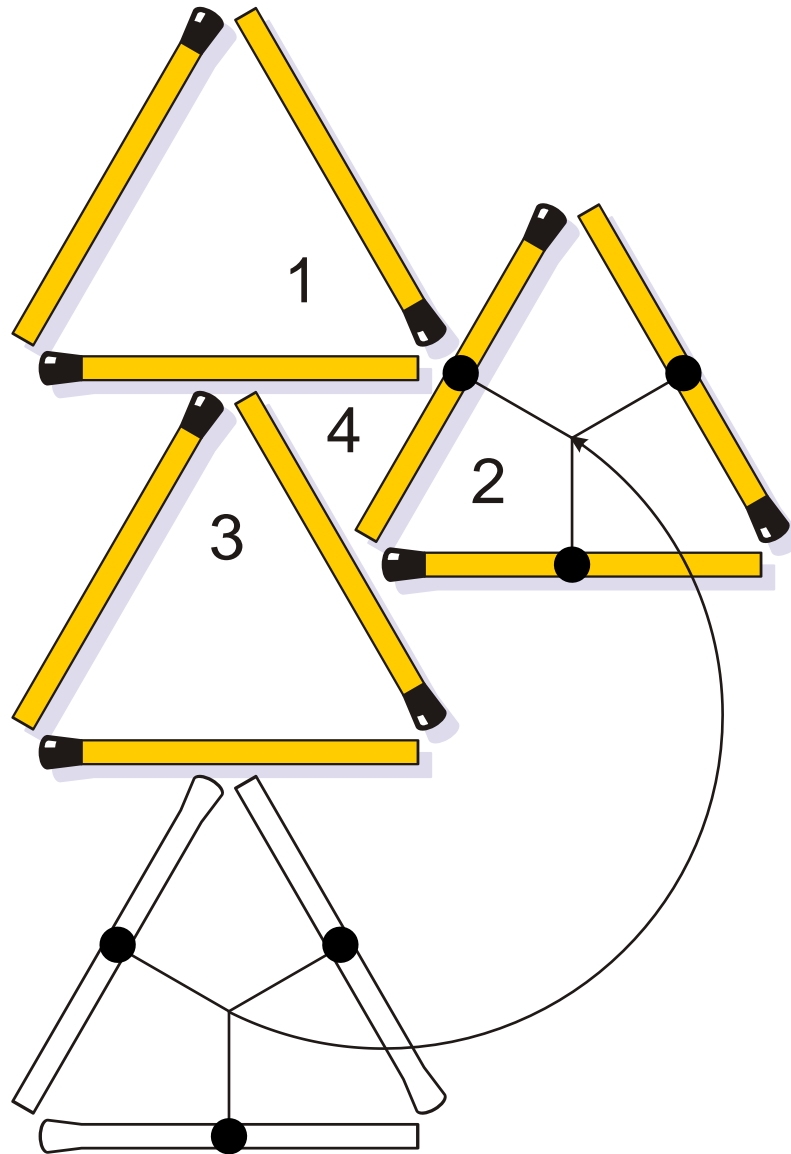

One of the basic solutions is given in the illustration. When you move the entire bottom triangle of three matches to the new position as shown, the three initial triangles remain plus one additional, smaller, equilateral triangle appears.

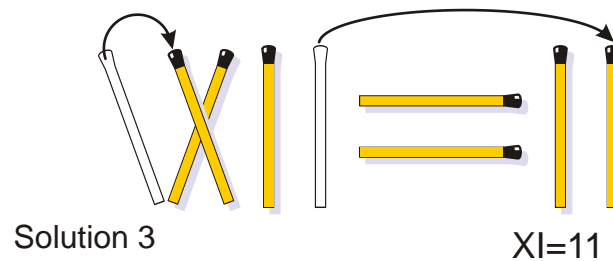
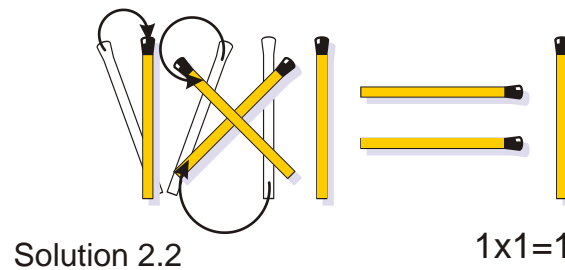
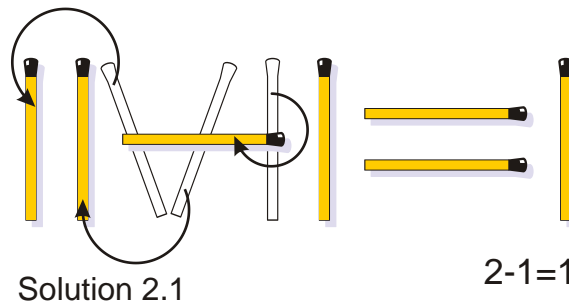
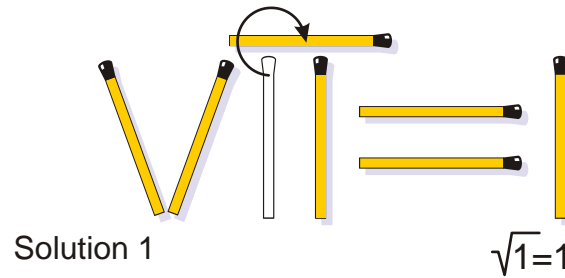

The solution to the first puzzle is shown in the upper illustration.

Two different solutions to the second puzzle are shown in the two middle illustrations.

The solution to the third puzzle is shown in the bottom illustration. This solution as well as the puzzle itself was contributed by Roger Kirkman.

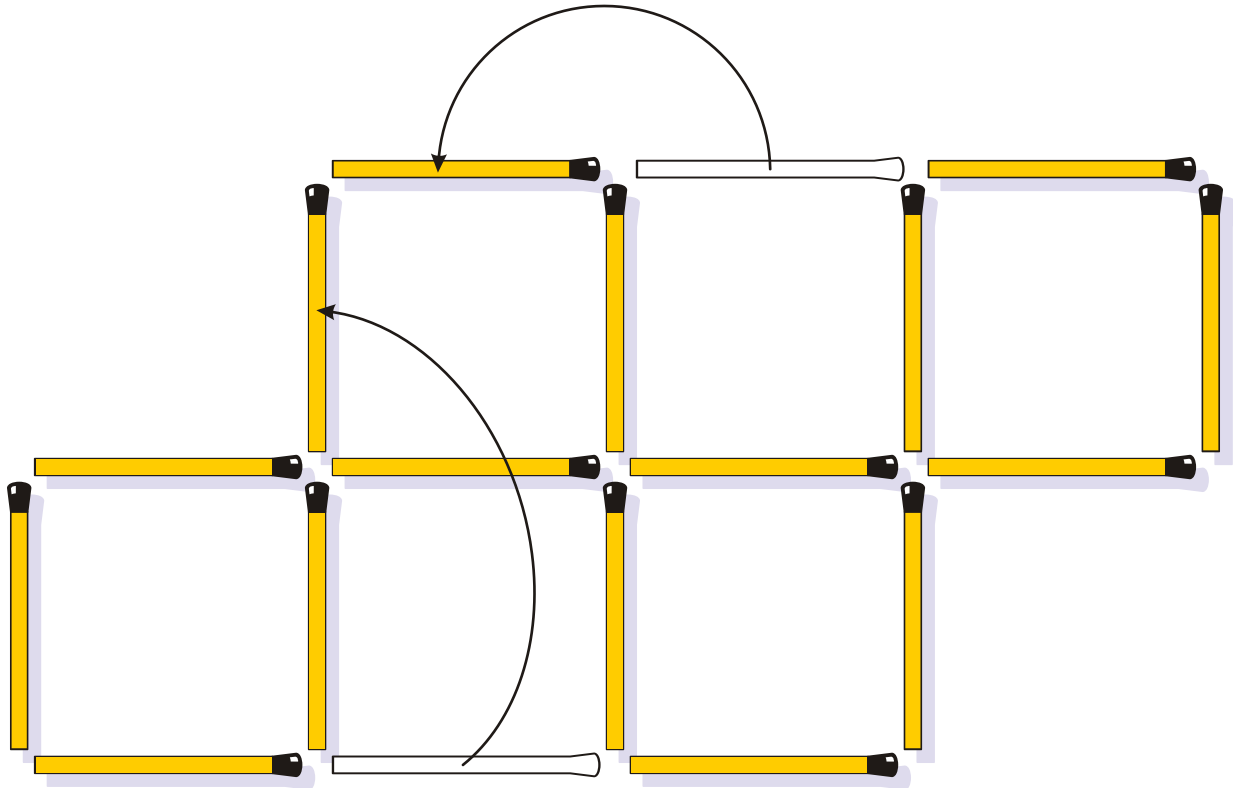

The solution is shown in the illustration.

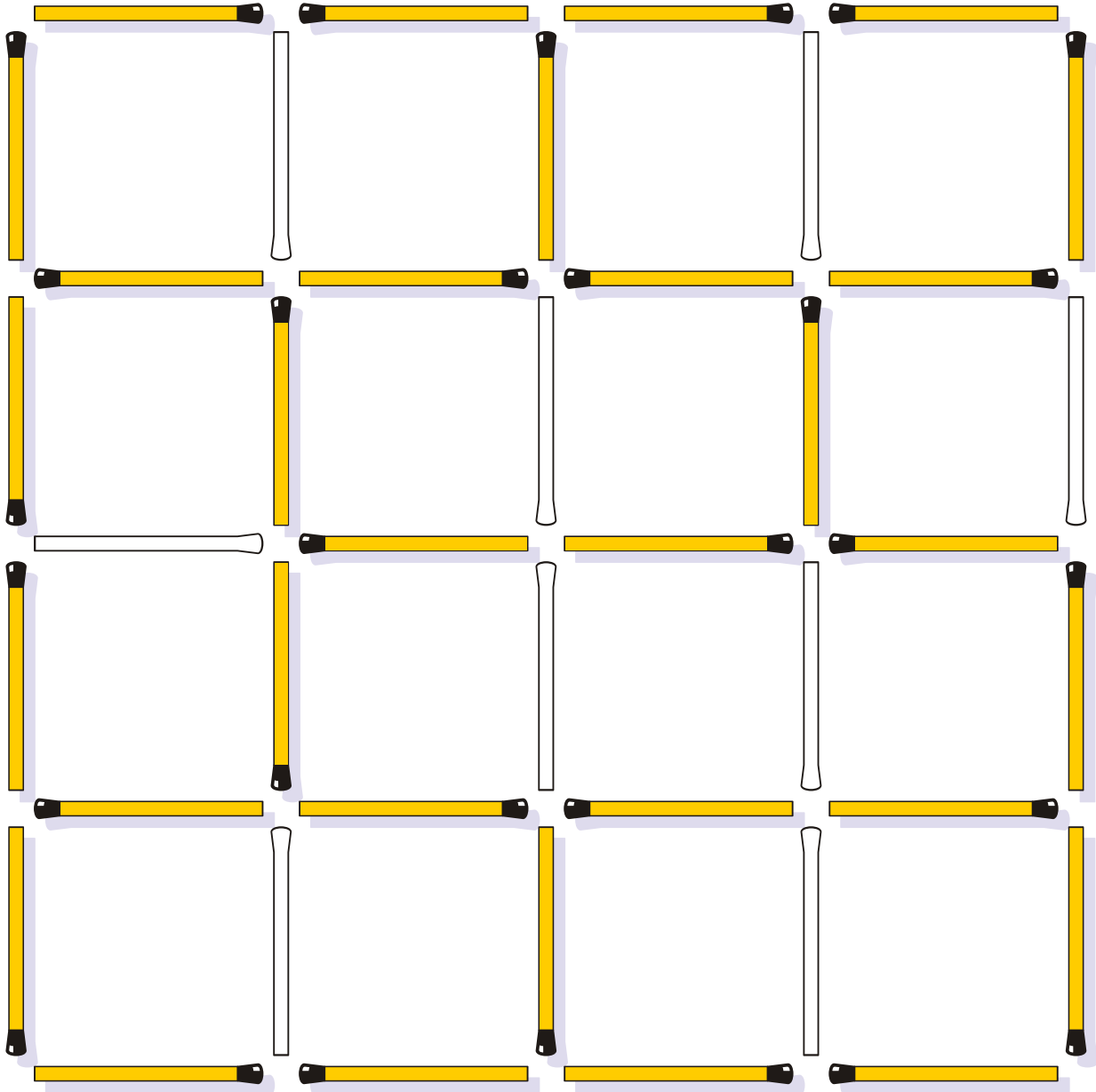

One of the solutions to this puzzle is shown in the illustration.

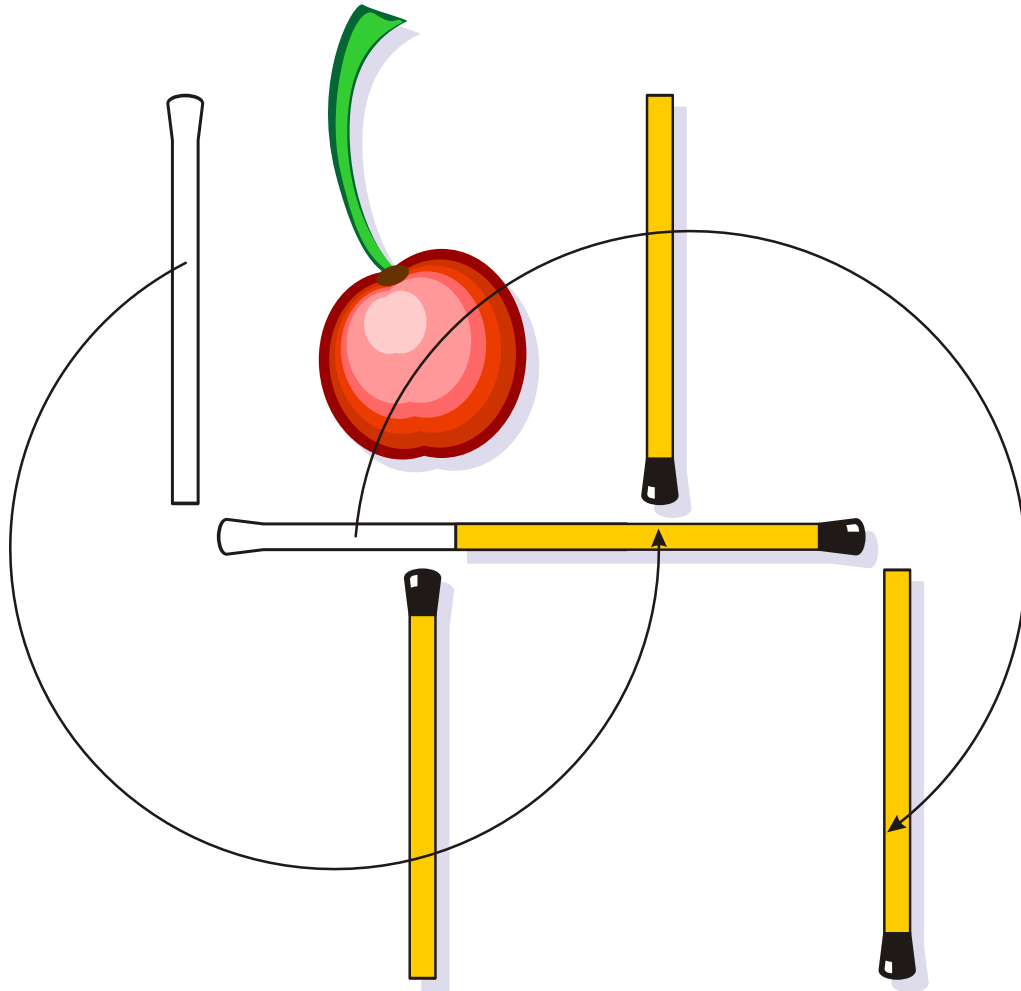

One of the two symmetric solutions to this puzzle is shown in the illustration

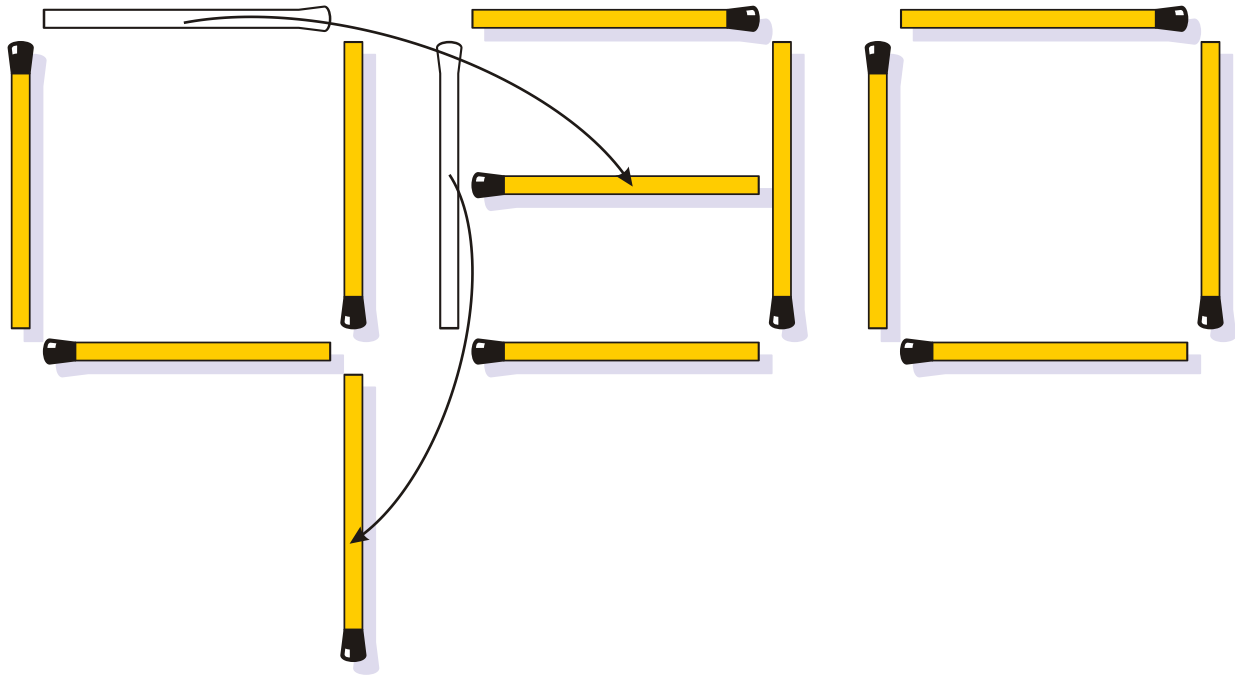

The solution is shown in the illustration.

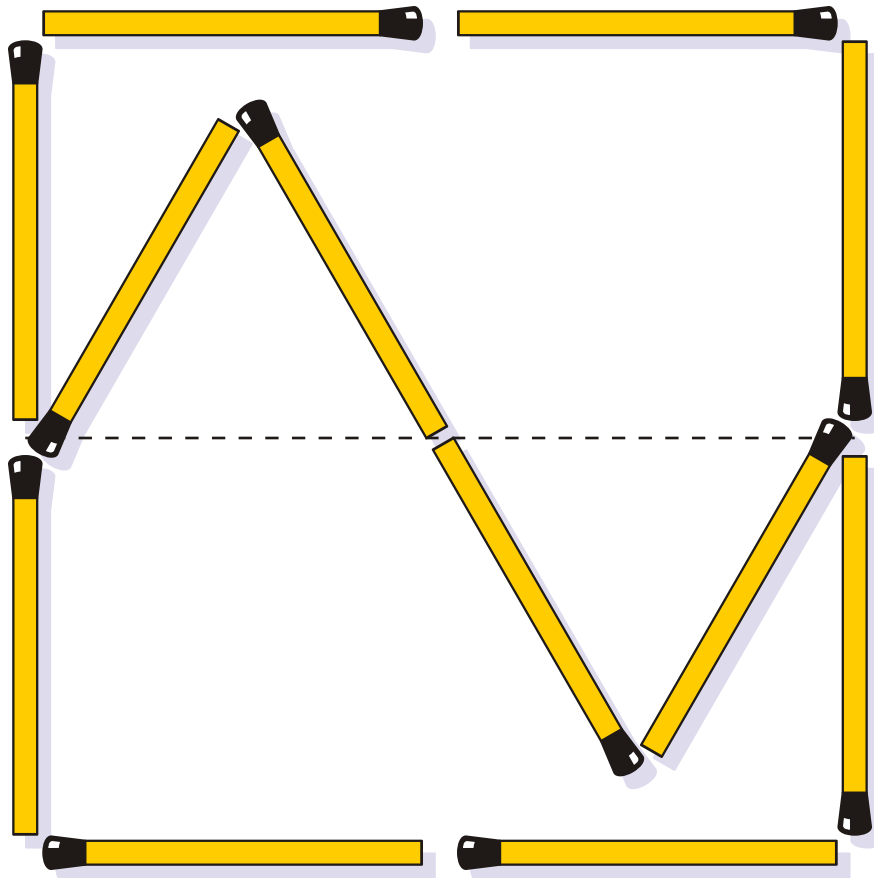

The solution is shown in the illustration.

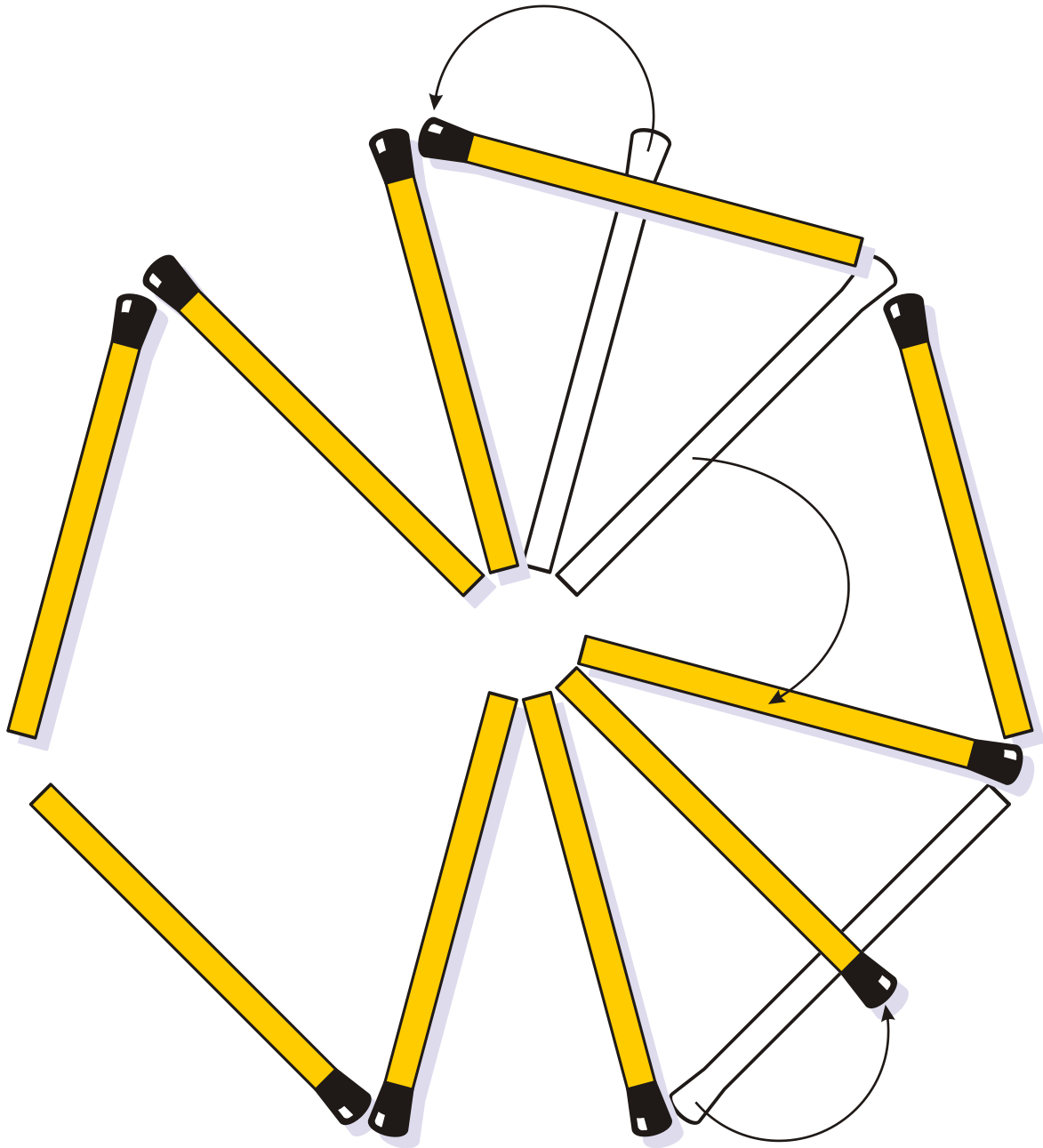

One of the two basic solutions to this puzzle is shown in the illustration

Last Updated: March 24, 2006

Page 23 of 27

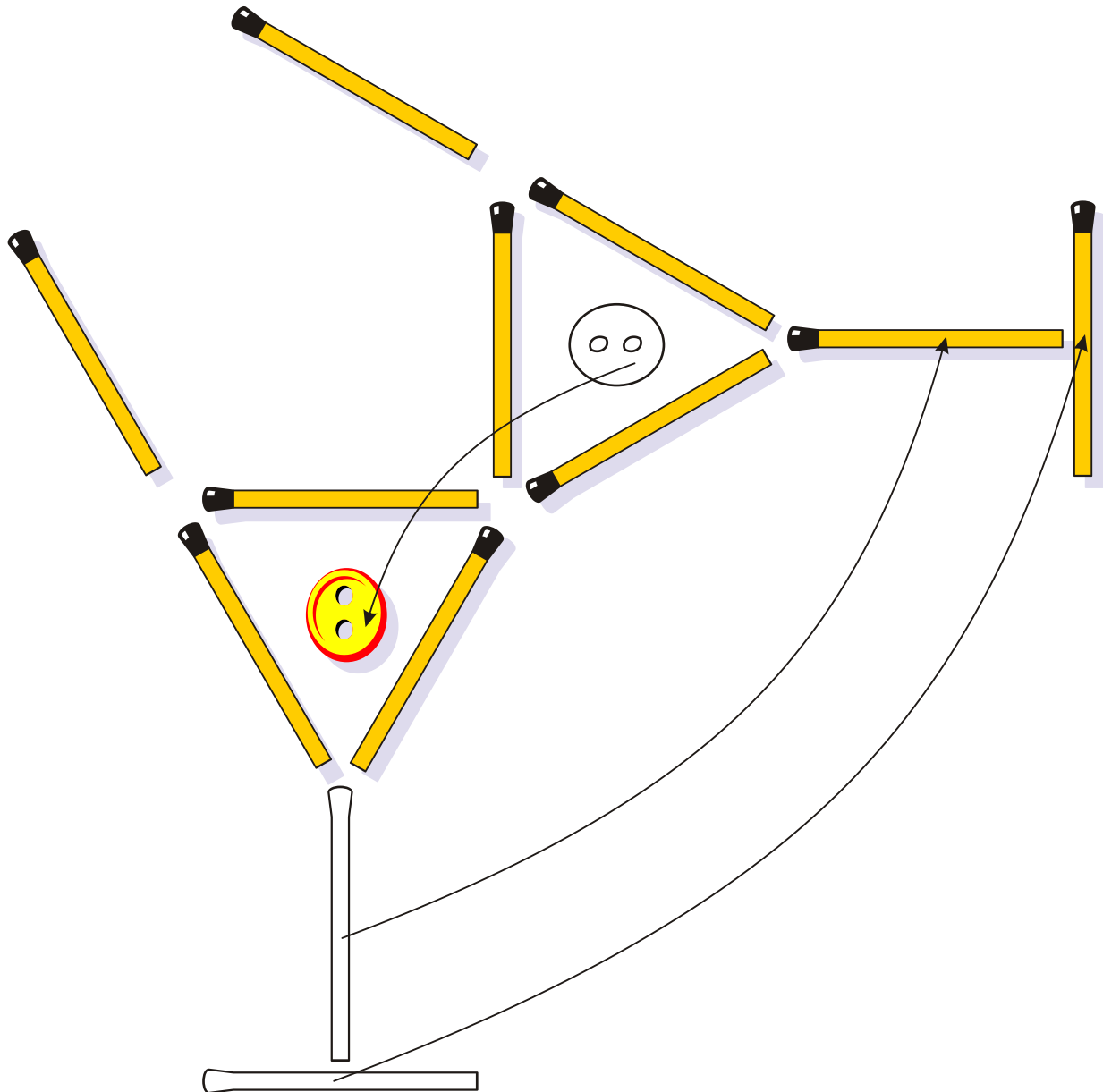

The solution is shown in the illustration.

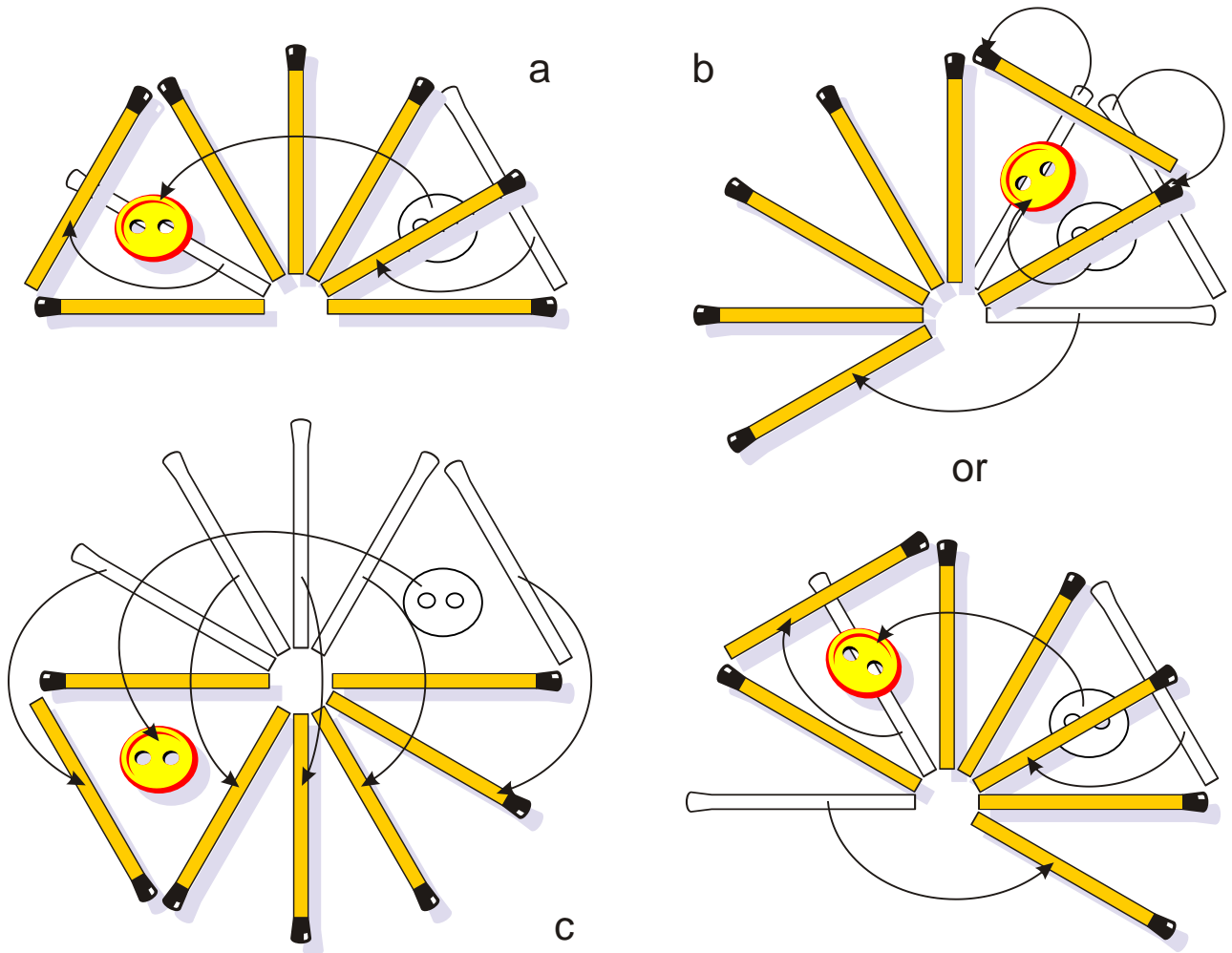

The solutions to the respective puzzles are shown in the illustration.

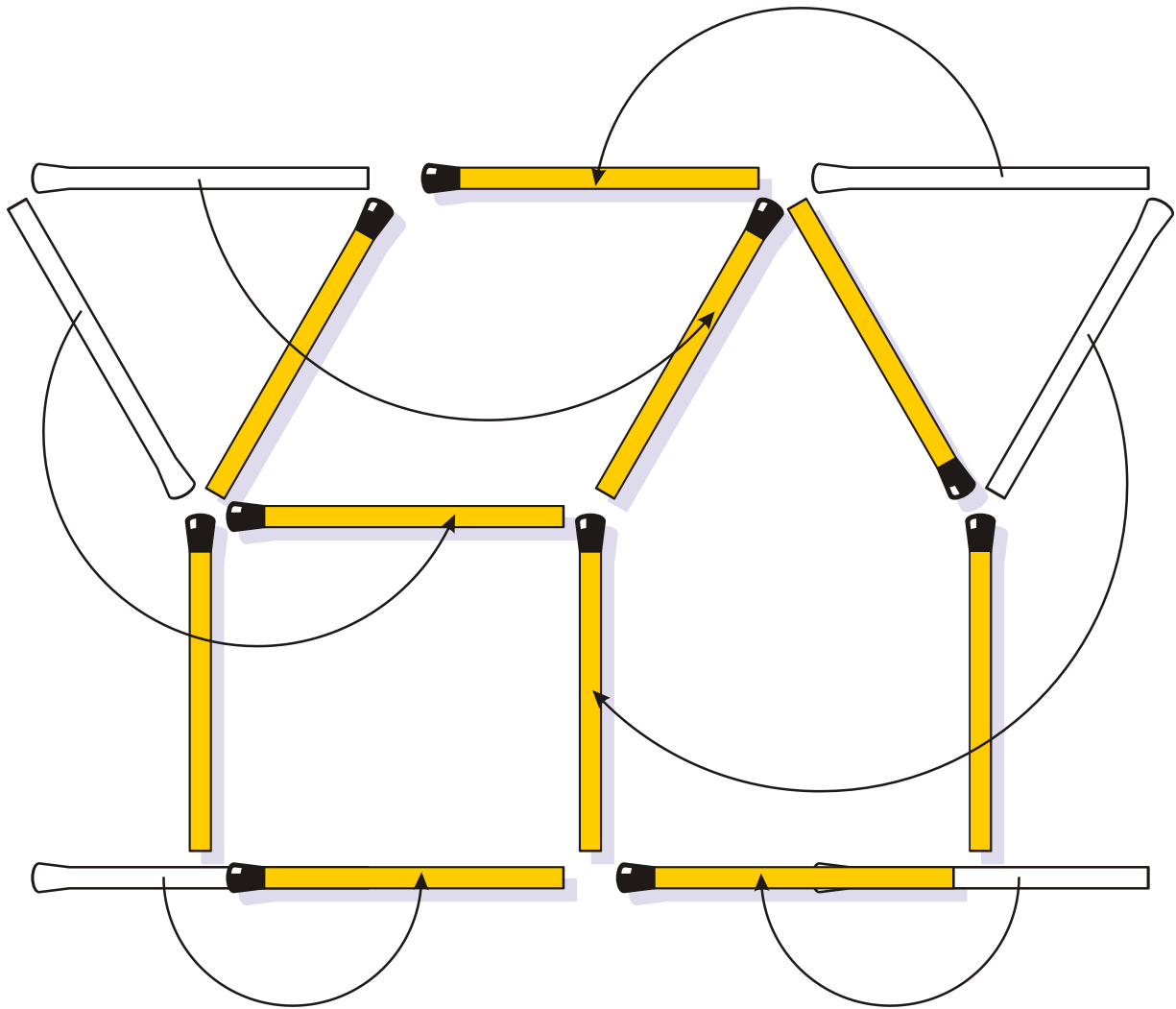

The solution is shown in the illustration.

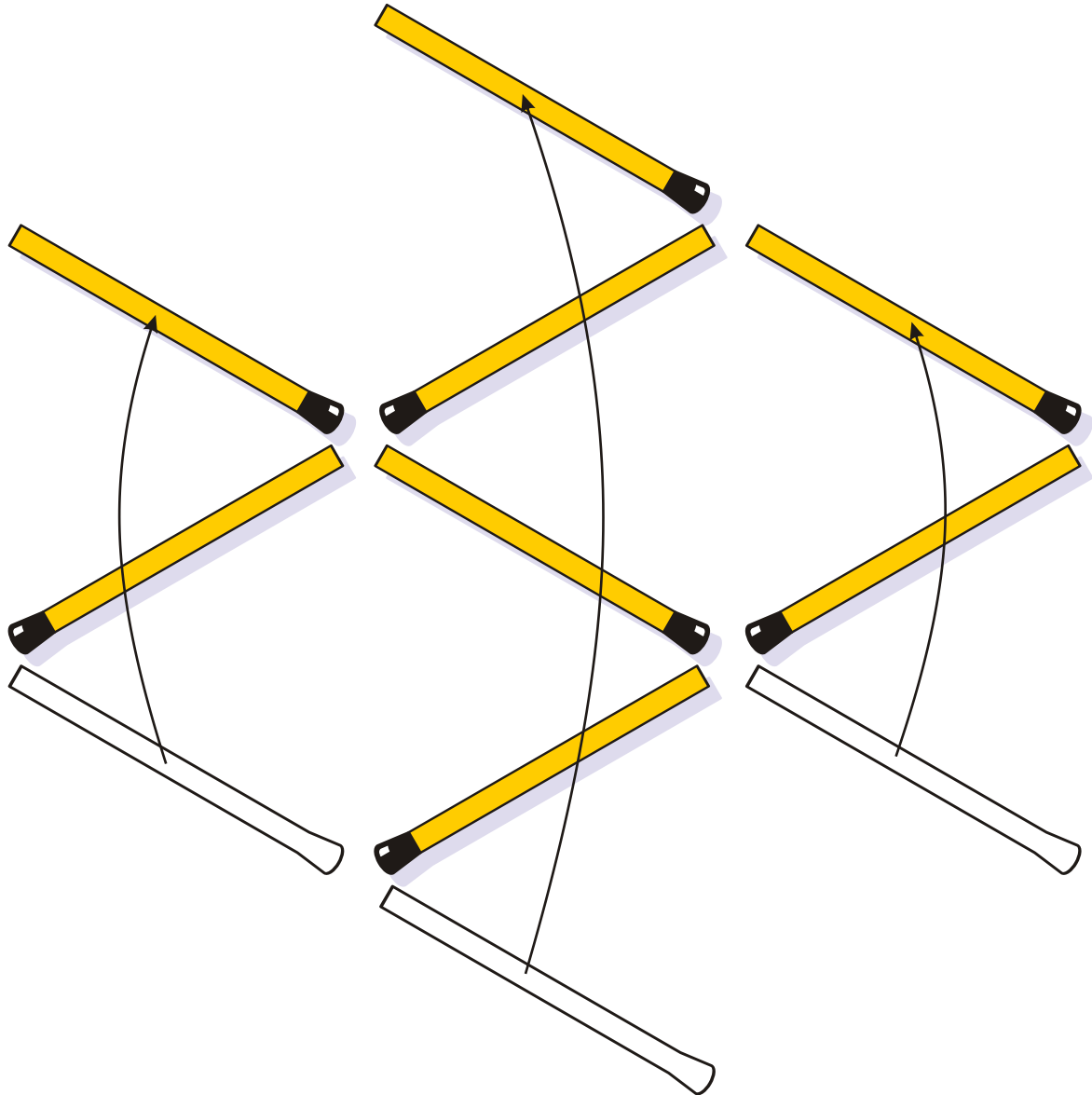

How to get one of the two symmetric solutions to this puzzle is shown above.